

EURO J4

PATENT

Article: **43520/02**



Plug-in 02 poles insulated – Yellow
Pitch 6,1mm – for width 6mm terminal blocks



GENERAL DATA

Series	EURO J
Item	43520/02
Weight/Piece	0.8 g
Customs tariff	8536901
Page/Catalog	136 / 01
Colour	Yellow
Q.ty p.pkg.	1 bag (= 100 pieces)
Q.ty p. box	-

TECHNICAL DATA / DIMENSIONS

Dimensions

Width mm	3
Length mm	11.2
Pitch mm	6.1

Technical data

Insulating material	PA68
Self-extinguishing degree acc. to UL94	V0
Jumper bar	Copper alloy
Nominal Current	25A

TECHNICAL DRAWINGS

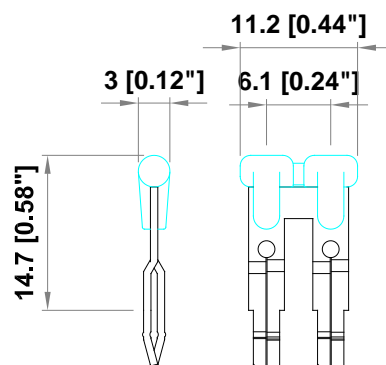

APPLICATION



Assembly plug-in jumper

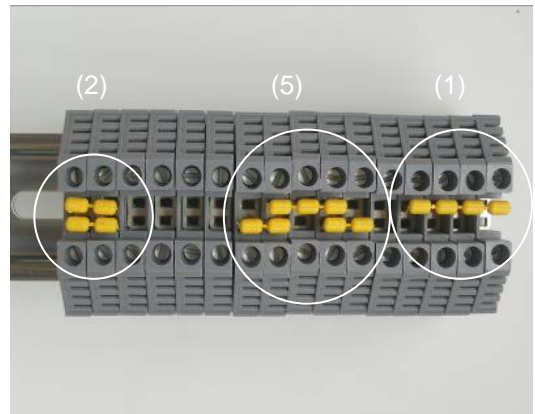
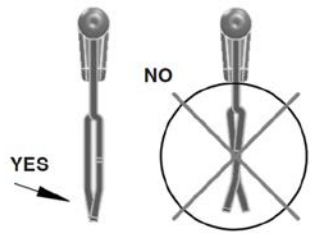
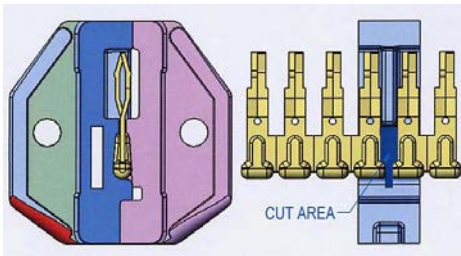

①



②

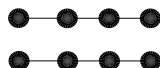

③

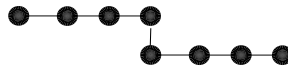

④



⑤

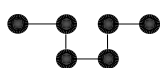

⑥

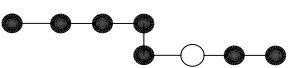

⑦



○ = Contatto tagliato / breaking off contact leg

ACCESSORIES
Additional items

Item	Description
43409 (all colors)	EURO 4 Feedthrough Terminal block
43550 (all colors)	EURO D4-2 Two stages terminal block grey
43551 (all colors)	EURO D4-2/1 Two stages block cross connected (plug-in only low stage)
43552 ÷ 43559	EURO D4-2 Two stage terminal block with electronic component (plug-in only low stage)
43427 (all colors)	EURO 4/15 Feedthrough Terminal block
42410 (all colors)	EURO Q4 Screwless Feedthrough Terminal block