

# EURO J4

Article: **43520/03**

PATENT



Plug-in 03 poles insulated – Yellow  
Pitch 6,1mm – for width 6mm terminal blocks



## GENERAL DATA

Series	<b>EURO J</b>
Item	<b>43520/03</b>
Weight/Piece	<b>1.2 g</b>
Customs tariff	<b>8536901</b>
Catalog	<b>01</b>
Colour	<b>Yellow</b>
Q.ty p.pkg.	1 bag (= 100 pieces)
Q.ty p. box	-

## TECHNICAL DATA / DIMENSIONS

### Dimensions

Width mm	3
Length mm	17.2
Pitch mm	6.1

### Technical data

Insulating material	PA68
Self-extinguishing degree acc. to UL94	V0
Jumper bar	Copper alloy
Nominal Current	25A

## TECHNICAL DRAWINGS

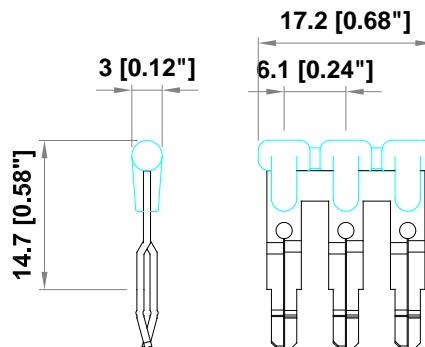

APPLICATION



Assembly plug-in jumper

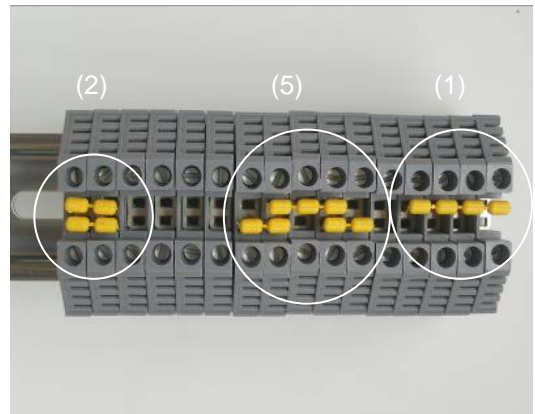
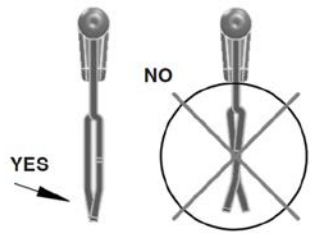
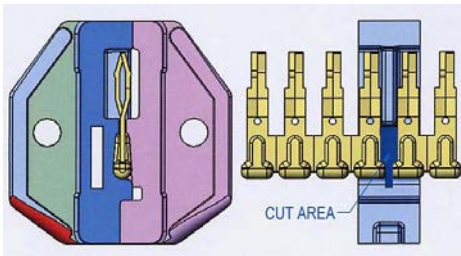

①



②

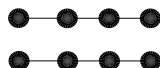

③

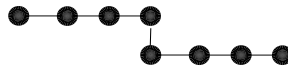

④



⑤

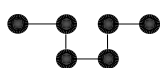

⑥

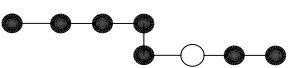

⑦



○ = Contatto tagliato / breaking off contact leg

---

**ACCESSORIES**
**Additional items**

Item	Description
<b>43409 (all colors)</b>	EURO 4 Feedthrough Terminal block
<b>43550 (all colors)</b>	EURO D4-2 Two stages terminal block grey
<b>43551 (all colors)</b>	EURO D4-2/1 Two stages block cross connected (plug-in only low stage)
<b>43552 ÷ 43559</b>	EURO D4-2 Two stage terminal block with electronic component (plug-in only low stage)
<b>43427 (all colors)</b>	EURO 4/15 Feedthrough Terminal block
<b>42410 (all colors)</b>	EURO Q4 Screwless Feedthrough Terminal block