

EURO J2.5

Article: **43525/02**

PATENT



Plug-in 02 poles insulated – Orange
Pitch 5,1mm – for width 5mm terminal blocks



GENERAL DATA

Series	EURO J
Item	43525/02
Weight/Piece	0.8 g
Customs tariff	8536901
Catalog	01
Colour	Orange
Q.ty p.pkg.	1 bag (= 100 pieces)
Q.ty p. box	-

TECHNICAL DATA / DIMENSIONS

Dimensions

Width mm	3
Length mm	10.2
Pitch mm	5.1

Technical data

Insulating material	PA68
Self-extinguishing degree acc. to UL94	V0
Jumper bar	Copper alloy
Nominal Current	20A

TECHNICAL DRAWINGS

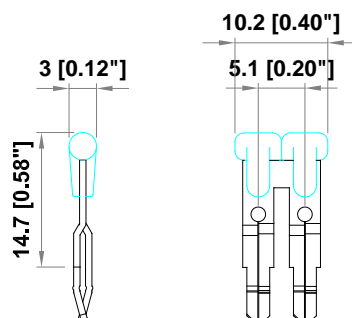

APPLICATION



Assembly plug-in jumper

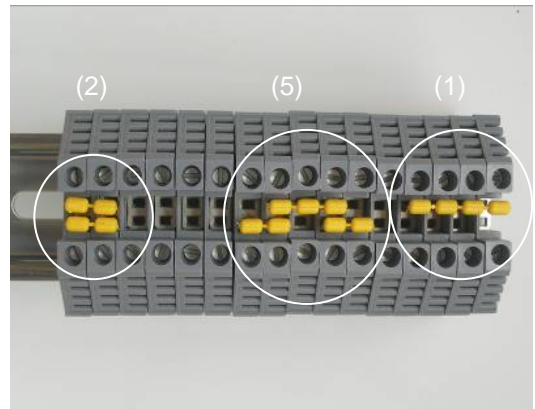
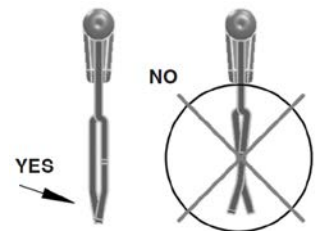
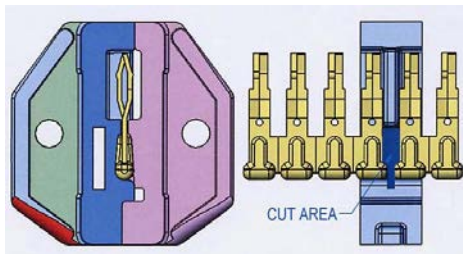

①

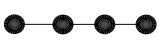

②

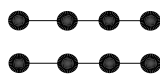

③

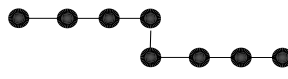

④



⑤

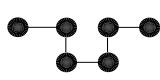

⑥

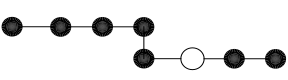

⑦



○ = Contatto tagliato / breaking off contact leg

ACCESSORIES

Additional items

Item	Description
43408 (all colors)	EURO 2.5 Feedthrough Terminal block
43560 (all colors)	EURO XM1/2V 2,5/35 multiple terminal block 1/2 vertical
43561 (all colors)	EURO XDV 2,5/35 vertical two stage terminal block
43567 (all colors)	EURO XM1/2VH 2,5/35 multiple terminal block 1/2 vert./horiz.
42560(all colors)	EURO XM1/2V 2.5 multiple t.b.1/2 vertical-spring connection
42561 (all colors)	EURO XDV 2,5/35 vertical two stage terminal block- spring
42567 (all colors)	EURO XM1/2V 2.5 multiple t.b.1/2 vert/horiz-spring system
42416 (all colors)	EURO Q 2.5 Feedthrough Screwless Terminal Block
42440 (all colors – all versions)	EURO QDJ/2.5 Two stage screwless Terminal Block (diode and LED)
42413 (all colors – no diode versions)	EURO QM1/2 2.5 Screwless Feedthrough terminal block multiple 1+2
42414 (all colors – no diode versions)	EURO QM2/2 2.5 Screwless Feedthrough terminal block multiple 2+2
42419	EURO QT 2,5 Screwless disconnecter terminal block